

FPO 100

Tank truck vane pump



Alfons Haar

Self-priming vane pump

- depending on selected pump size up to 1500 l/min with $\Delta p = 7$ bar

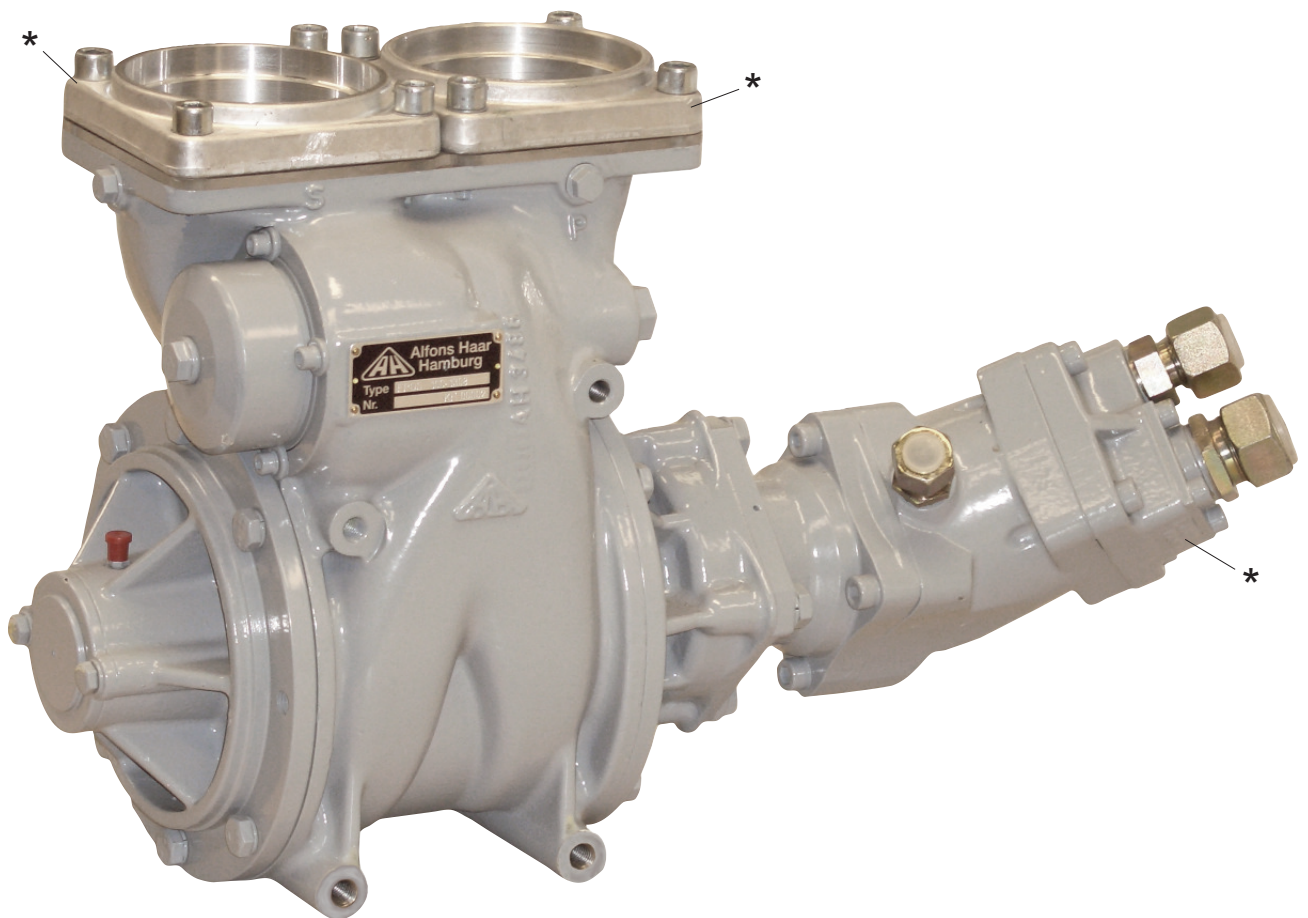

**The Alfons Haar pump is Ex II 2G cT3 CE certified,
an operating without a flame arrestor** is possible !**

- computer optimized 4" suction cross section for a quiet pump operation and high discharge rate
- large integrated pneumatic or mechanical by-pass valve
- ideal 4" block flange for connection of the pipework to the pump in the tank truck
- very good blow down for product change
- excellent working life and simple service
- PTO or hydraulic drive
- Ideal for hydraulic drive with an efficiency of 80% and more

* accessories

** under compliance of the certified ATEX conditions

FPO 100

Tank truck vane pump



FPO... 100-1135

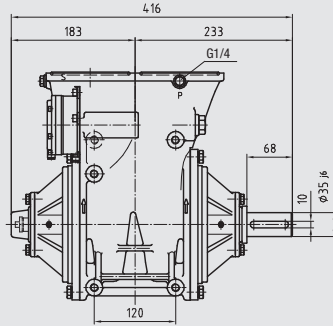

Dimensions

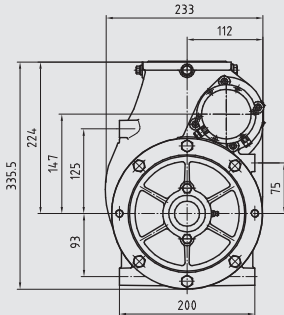

FPO G 100-

Flow rate

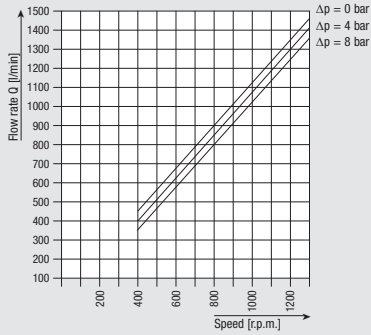

Input power

The input powers of the pump are minimum values for non-viscous media with viscosities up to approx. 12 cSt as e.g. heating oil EL, diesel and motor gasoline.

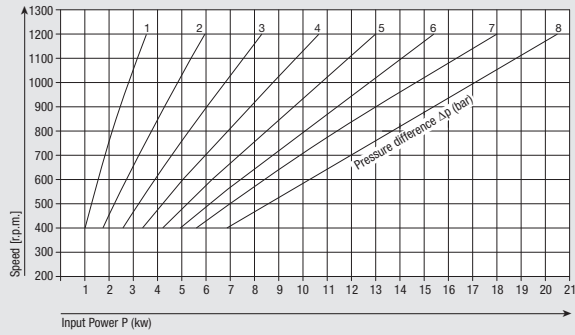

FPO... 100-1308

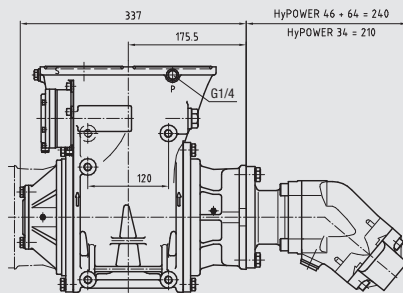

Dimensions

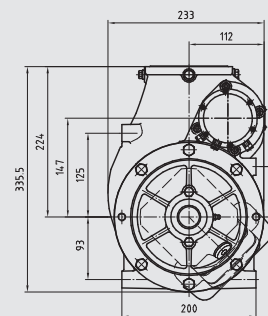

FPO S 100-

Flow rate

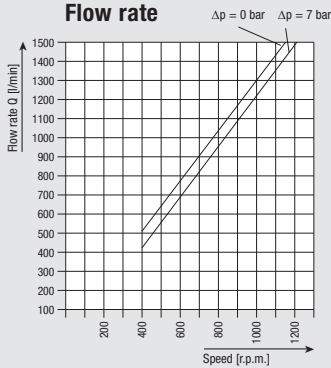

Input power

The input powers of the pump are minimum values for non-viscous media with viscosities up to approx. 12 cSt as e.g. heating oil EL, diesel and motor gasoline.

